

Full LCD Keypad for EC-i, EC-PCB, ESX-1 & ESX-2

Specifications

Voltage	12VDC
Current Draw	80mA max
Mounting Height	1.2m to 1.5m (Recommended)
Bus Connection	Screw terminals or ARR14 Loom
IP Rating	IPX0 (indoor use only)
Output Control	Up to 32 Outputs
Backlighting	Programmable
Mounting	Vertical flush box or direct fix
Dimensions	H133 x W87 x D25mm
Warranty	5 years

Compatible Control Panels

EC-i, EC-PCB, ESX-1 & ESX-2

Function

The EC-LCD displays up to 248 Inputs, 32 Areas, 32 Outputs, 32 Keypads, 32 Time Schedules, 32 Access Levels, 2000 Users & more than 10,000 History Events.

EliteCloud APP & Network Information *(Accessed from the home screen)*

Serial Number: Press & hold number 7 to view the serial number.

MAC Address: Press & hold number 8 to view the control panel MAC Address.

IP Address: Press & hold number 9 to view the control panel IP Address.

Bus Connection & Distance

Fitment

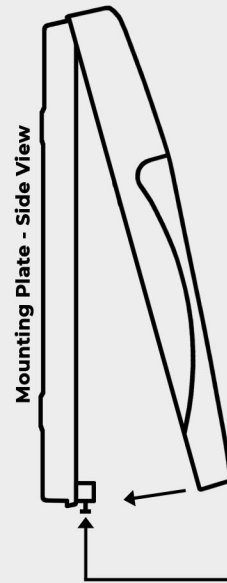

- Fit mounting plate level on the wall.
- Make sure the entire system is powered down.
- Terminate POS, NEG, CLK & DAT as detailed in the 'Hardware & Cabling Overview' below
- Place keypad over mounting plate as shown, then click in the bottom before tightening the securing screw at the base.

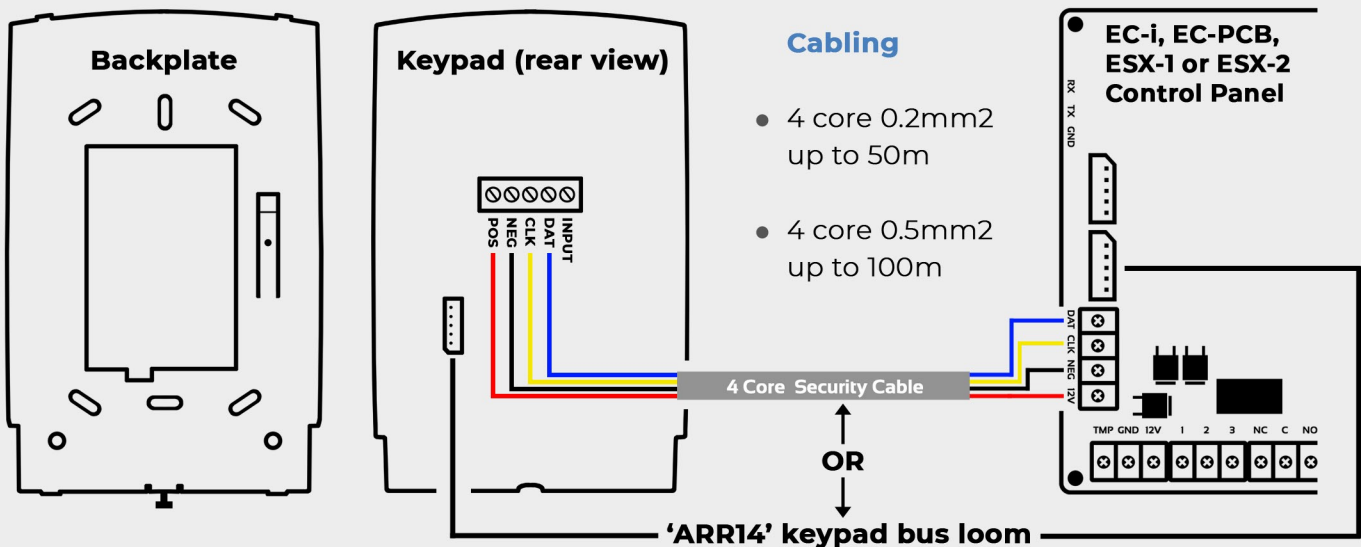

Cabling

- 4 core 0.2mm² up to 50m
- 4 core 0.5mm² up to 100m

Button & Icon Overview

ARM Button



The 'ARM' button will ARM Area 1 & also Disarm during the exit delay period (by default).

STAY Button



The 'STAY' button will Stay arm Area 1 & also Disarm during the exit delay period (by default).

ENTER Button



Press to perform the following functions:
Confirm any programming or code entry.
Clear an incorrect code.

CONTROL Button



Allows users to operate any Output from 1 to 32 by pressing & holding 'CONTROL' then entering the output (or multiple outputs) followed by 'ENTER'.
For example: CONTROL < 04 > ENTER for Output 4.
This is programmed at addresses 34 & 83.

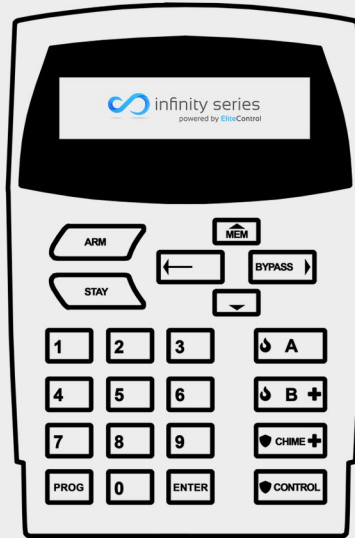

☠ ☠ + Symbols

Buttons 'A', 'B', 'CHIME' & 'CONTROL' contain the Panic, Fire & Medical symbols. These can be configured at addresses 72, 84 to 86 & 187.

MEM Button



Used to access 'Current System Faults' & control panel 'Event History'. See following page for more information.

BYPASS Button



Used to bypass or exclude any selected input for one 'Arm' cycle. See following page for more information.

A & B Button



A & B buttons can be assigned to Arm/Disarm any area on the control panel. See addresses 78 to 81 in the full manual for more information.

CHIME Button



Any input from 1 to 248 can be programmed as a 'Chime Zone' (at address 123) & then linked to any keypad from 1 to 32 (at address 136).

Addressing

Each keypad on the EC-i or EC-PCB control panel must be individually addressed. I.e. Once commissioned there should never be 2 keypads on one system with the same address. This also includes any access control reader/keypad that is connected via an 'EC-A2' 2 door access module.

Each alarm keypad is supplied as 'Keypad 1' by default & can be changed to any keypad address on the system (from 1 to 32) as detailed below:

Change the EC-LCD Keypad Address (Accessed from the Home Screen)

- Press 'PROG' followed by 'BYPASS' & then 'ENTER'
- The current keypad address will display as per the example in 'Figure 1'
- Now enter the desired keypad address (from 01 - 32) followed by the 'ENTER' button to confirm & you will automatically return to the 'Home Screen'

Figure 1

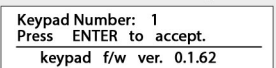

Enter Installer Programming on the EC-LCD (Accessed from the Home Screen)

Access to installer programming allows you to change almost all of the system parameters via the 'EC-LCD' keypad. Please consult the full manual for a full list of programming addresses & control panel information.

- Press 'PROG' followed your installer code (default 000000) & then 'ENTER'.
- 'Installer USERS' will display to indicate you are in installer programming as shown in 'Figure 2'

Figure 2



Important: Keypad programming can not be accessed if the system is 'Armed' or 'Stay Armed'.

Exit Programming on the EC-LCD (Exiting installer or client programming)

- Press the 'PROG' button (sometimes 2 or 3 times) until the screen in Figure 3 is displayed, then press the 'ENTER' button to exit to the 'Home Screen'.

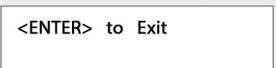

Figure 3



System Faults & Event History

Example

Current Faults
Battery Low

- Current system faults are accessed by pressing the  button from the 'Home Screen'.
- Each press of the  button will step through the current system faults one by one.
- Once there are no more system faults to view the 'MEM' button will begin to show the control panel 'Event History' from newest to oldest.
- The  button can then be pressed if you would like to go back to more recent 'Event History'.
- More than 10,000 'History Events' can be stored by the control panel & displayed on the 'EC-LCD'.
- Press the 'ENTER' button to return to the 'Home Screen'. Alternatively the 'Current System Faults' or 'Event History' menu will automatically exit to the 'Home Screen' after 20 seconds if no buttons are pressed.

Below is a list of 'Current System Faults' that can be displayed on the 'EC-LCD' keypad:

1. Power Failure	7. Supervised Fail
2. Battery Low	8. Sensor Watch Fail
3. O/P or Fuse Fail	9. Area Delinquency
4. Phone Line Fail	10. Keypad Missing
5. Radio Batt Low	11. Dialer Failure
6. Pendant Batt Low	

Backlight Adjustment

Example







Keypad 1 Backlight
50

The backlighting of each 'EC-LCD' keypad can be adjusted from within 'Installer Programming' at address 95. This value is set as a percentage from 0 - 100, where '0' is off and '100' is full brightness.

Keypad backlighting can also be adjusted from the web browser or EliteCloud dashboard within the 'Keypads' > 'Display & Chime' tabs.

Beep Tone Adjustment

The beep tone of each keypad can be adjusted from high to low frequency (and vice versa) as follows:





- Press & keep holding the  button, then within 2 seconds press the  button to increase the frequency or the  button to decrease the frequency.
- You can continue to hold down the  button and change the frequency with each press of the  or  buttons until you are satisfied with the tone.

Editing Text (You must be in 'Installer Programming' to edit text)

Example

User 1 Name
John Smith

Custom names can be programmed via the EC-LCD. These names will appear on the keypad display & also within the control panel 'Event History'.

Within the following addresses (below) the   buttons can be used to change between lower & upper case. The   buttons are used to move the cursor. Use the associated keys on the alphanumeric keypad to enter the text that you require, then press  to confirm.

User Names: P 16 E 1 - 2000 E **Idle Display Name:** P 25 E 14 E **Output Names:** P 31 E 1 - 32 E
Area Names: P 69 E 1 - 32 E **Keypad Names:** P 100 E 1 - 32 E **Input Names:** P 169 E 1 - 248 E

Custom text can also be input/entered via the web browser or EliteCloud dashboard. This can then be pushed to all alarm keypads on the system via the P 200 E 8 E address.

Keypad Input Terminal Wiring

The 'EC-LCD' or 'EC-LCD PROX' alarm keypads have a zone 'Input' terminal which can be assigned as a regular input that reports back to the main control panel.

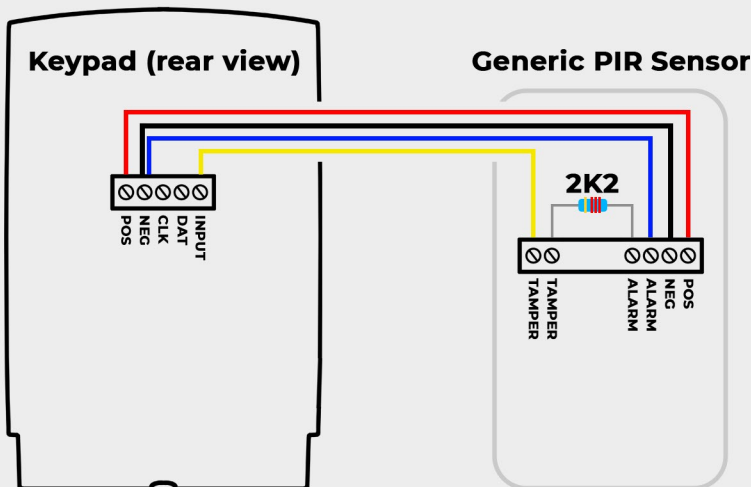

Keypad Input Keypad Programming

The EC-LCD & EC-LCD PROX Input terminal only supports 2K2 single EOL configuration & is directly associated with the keypad address.

For example: If the keypad address is 'Keypad 5' then the Input terminal will become 'Input 5' on the main control panel.

Enabling Keypad Input

To enable the keypad input, turn option 4 ON at address 122.

For example: To enable the input terminal on 'Keypad 5' press P 122 E 5 E 4 E.

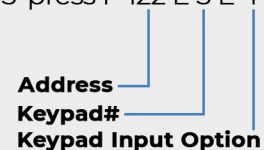

Keypad Input Web Programming

Enabling a keypad input can also be programmed from within the web browser or EliteCloud dashboard. This is found under the 'Inputs' > 'Options' > 'Keypad Input' option ON

Keypad Wiring (continued)

Keypads can be wired both 'In Line' or 'Star Wired' on the EC-i & EC-PCB providing the total combined bus length does not exceed 300m when using 4 core 0.5mm security cable.

This 300m total bus length also includes any bus expander devices such as the EC-A2, EC-Z8 & EC-O4, however any access reader connected to the EC-A2 is not included in the 300m total.

This example shows 3 keypads 'In Line' & 2 keypads 'Star Wired' with an acceptable total bus distance of 300m.

